

P2100

OPERATING MANUAL

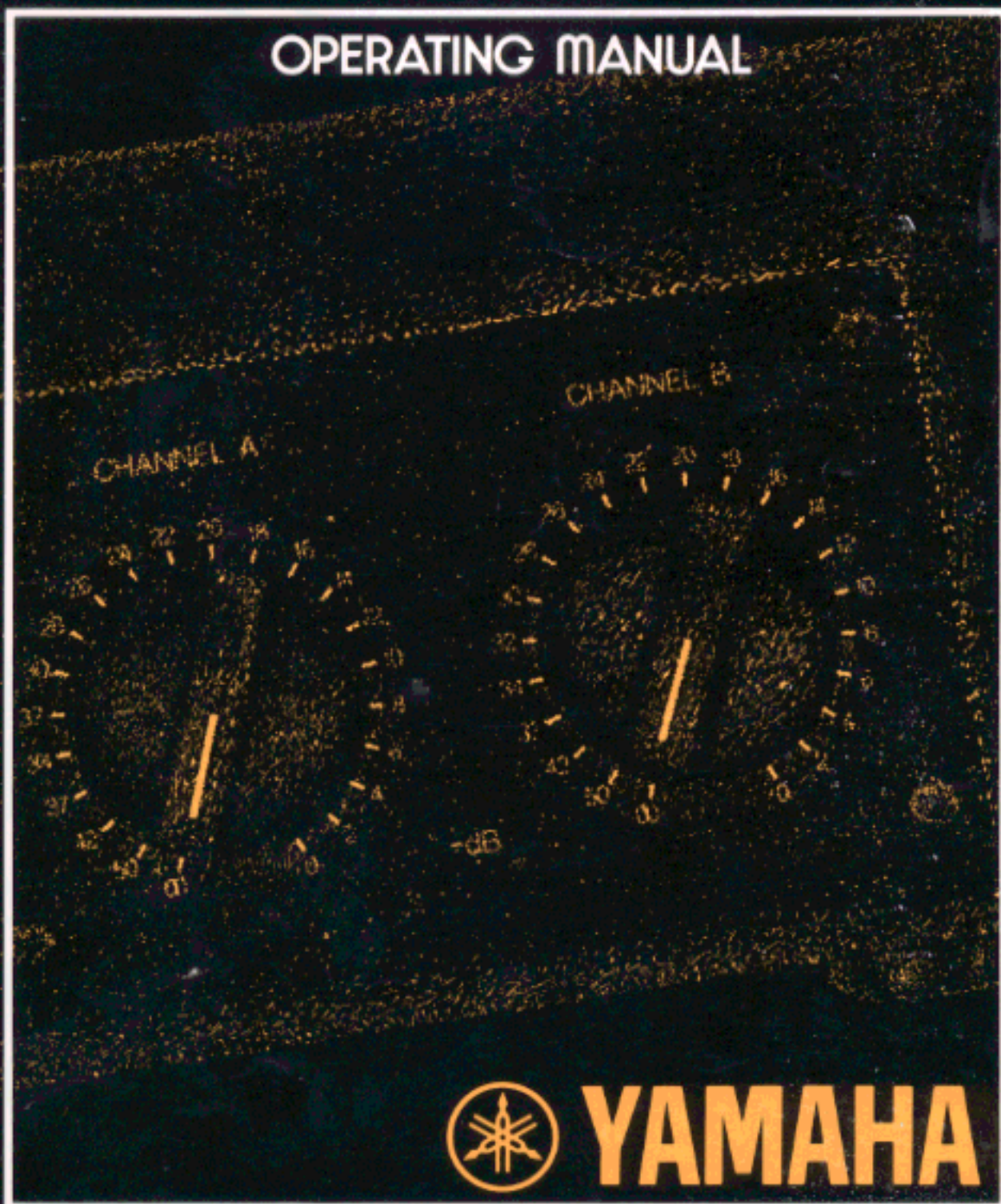

ABOUT THIS MANUAL

SCOPE

The P2100 is a system oriented amplifier, made to be used in conjunction with mixers, consoles, frequency dividing networks and speakers — those made by Yamaha or by other manufacturers. Like any power amplifier, the P2100's performance depends on system design and installation, in addition to its own capabilities. Thus, the P2100 Operator's Manual is system oriented, describing system design parameters and installation techniques, as well as the operation and performance of the P2100.

Additionally, this manual reviews a few of the basic mathematic tools used in system design, from dB to Ohm's law.

ORGANIZATION

We recommend that you read the entire Operator's Manual. However, if you are using the P2100 in an existing system, and you are familiar with high power amplifiers, the BRIEF OPERATING INSTRUCTIONS (Page ONE 1) contain all the information necessary for basic connections and operation.

The SPECIFICATIONS in sections THREE and FOUR are highly detailed, including oscilloscope photos, and discussions of the P2100's excellent performance specifications. The last part of Section FOUR is a discussion of the advantage of professional equipment, like the P2100, compared to hi-fi or semi-pro equipment.

The INSTALLATION AND DETAILED OPERATION section, which begins on Page SIX 1, includes more complete instructions, special considerations for using the P2100 "on the road," as well as in permanent commercial and studio installations. This section also covers grounding and shielding concepts, cabling considerations, and several other topics.

The APPLICATIONS section, which begins on Page SEVEN 1, discusses the use of the P2100 in several typical setups, and includes wiring diagrams. This section also covers other devices that are normally associated with a power amplifier, from graphic equalizers to compressor/limiters.

The APPENDIX, on Page EIGHT 1, discusses definitions of a number of the terms used in the manual, and reviews some of the basic mathematic tools used in system design, such as the dB, Ohm's law, voltage division, and power formulas.

INDEX

THE P2100 BRIEF OPERATING INSTRUCTIONS	SECTION ONE
INTRODUCTION	SECTION TWO
GENERAL SPECIFICATIONS	SECTION THREE
PERFORMANCE GRAPHS & A DISCUSSION OF SPECIFICATIONS	SECTION FOUR
THE DISTINCTION BETWEEN PROFESSIONAL AND HI-FI EQUIPMENT	SECTION FIVE
IMPEDANCE	1
OPERATING LEVELS	2
DYNAMIC RANGE	2
GAIN OVERLAP AND HEADROOM	4
INPUT SENSITIVITY RATINGS	4
PROFESSIONAL EQUIPMENT ADVANTAGES	4
INSTALLATION AND DETAILED OPERATION	SECTION SIX
PHYSICAL MOUNTING	1
CABLING AND IMPEDANCE MATCHING	2
ACTIONS OF THE P2100 PROTECTION CIRCUITS	13
GROUNDING AND SHIELDING	13
AC: POWER, FUSES, ACCESSORY OUTLETS, WIRING, SAFETY	16
MONO OPERATION	17
APPLICATIONS	SECTION SEVEN
BIAMPLIFICATION AND TRIAMPLIFICATION	1
ECHO, REVERB AND DELAY	3
COMPRESSION AND LIMITING	3
EQUALIZATION, HIGH AND LOW PASS FILTERS	4
SPEAKER PROTECTION	6
SPECIFIC APPLICATIONS	7
APPENDIX	SECTION EIGHT
DEFINITION OF TERMS: dB, dBV, dBm and dB SPL	1
SPECIAL USE OF dB (VOLTS) IN THIS MANUAL	1
OHM'S LAW	2
POWER	2
IMPEDANCE	3
SERIES AND PARALLEL IMPEDANCE CONNECTIONS	3
VOLTAGE AND CURRENT DIVISION	4
BALANCED, UNBALANCED, AND FLOATING CIRCUITS	5
TRANSFORMERS	5

SECTION ONE¹

THE P2100 BRIEF OPERATING INSTRUCTIONS

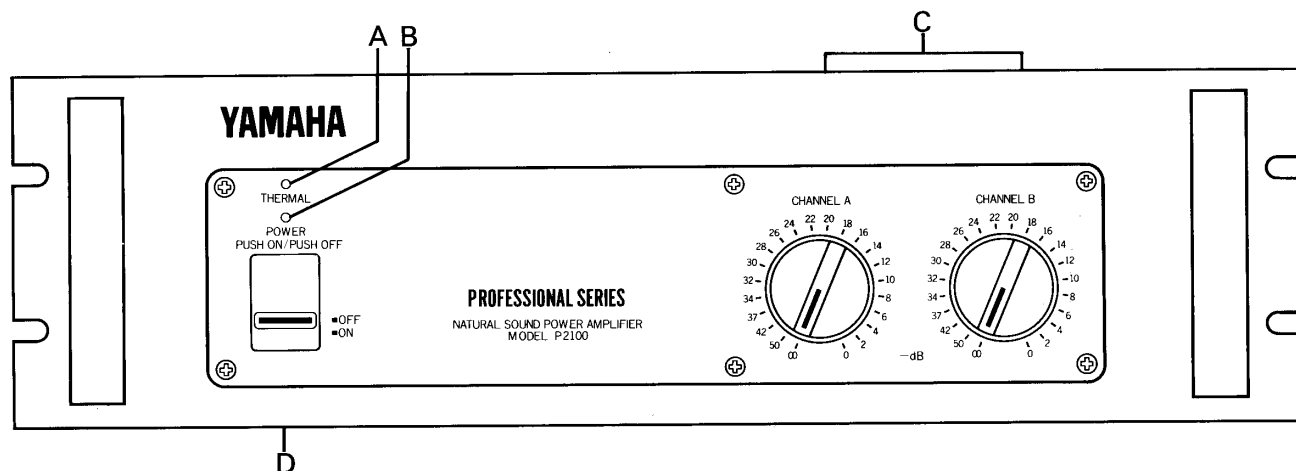

Fig. 1 – P2100 Front Panel

- A. **Thermal Warning Indicator**
Warns of overheating *before* thermal protection circuit turns off the AC power.
- B. **Power Indicator**
Glowes when the Power Switch is "on."
- C. **Input Attenuators**
Calibrated, stepped input attenuators lower input signal levels ahead of any amplification stages.
- D. **Power Switch**
Controls AC power to the P2100.

NOTE:

The P2100 is made to be mounted in a standard 19" wide electronic equipment rack. It takes up 5-1/4" of vertical space, and extends 11-1/4" behind its front panel. For portable racks, we recommend bracing the rear of the amplifier.

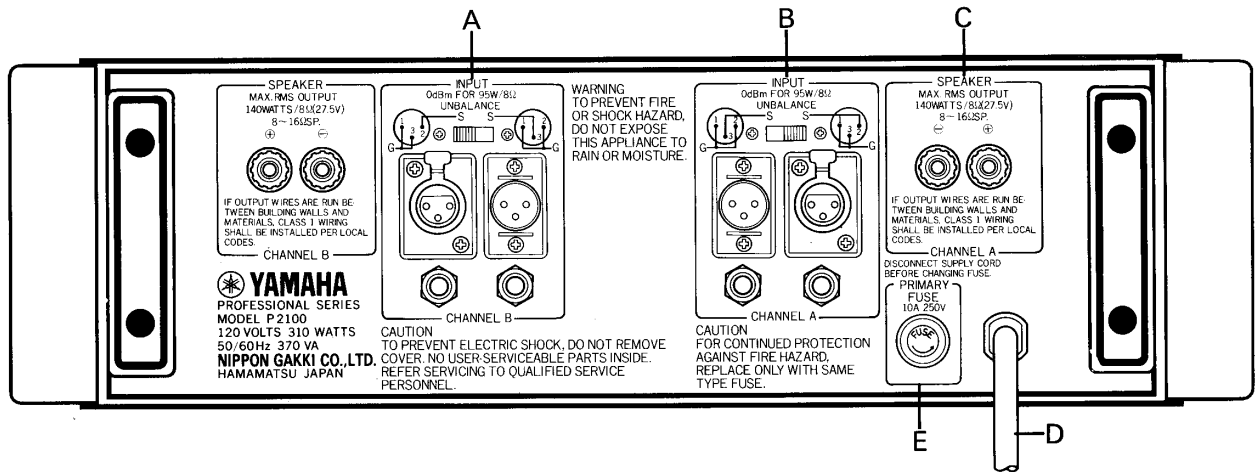

Fig. 2 – P2100 Rear Panel**

A. Input Connectors

The two XLR input connectors on each channel are unbalanced and are wired in parallel with each other and with the two phone jacks (tip/sleeve type).

B. Input Polarity Switch

Determines the polarity of the two XLR input connectors (Pin 2 or Pin 3 "hot"); does not affect the two phone jacks. See diagram on P2100 rear panel.

NOTES:

1. Input impedance is 25k-ohms minimum; 0dB (0.775V) produces 95 watts output into 8 ohms (27.6V).

2. Input channels may be paralleled by connecting them together with phone to phone or XLR to XLR cables as shown on Page SIX 7.*

3. Input transformers for matching or isolation, should be located several inches from the P2100's power transformer for maximum hum rejection.

C. Output Connectors

Standard 5-way binding posts (3/4" spacing) accept banana plugs or direct-wired connections. (U.S., Canadian and Australian models)

Conventional binding posts accept direct-wired connections. (other territories' models)

NOTES:

1. Maximum power output into 8 ohms is 110 watts per channel; power output rises at lower impedances.

2. Protection circuitry lowers power output when load impedance falls below 2.5 ohms.

D. AC Power Cord

For the U.S. and Canadian models, the P2100 requires a 117V AC 50 or 60Hz line (105V min., 135V max., 3.9 amps max. at 120 volts).

For the Australian model: 240V AC 50 or 60 Hz.

For other territories' models, an internal voltage selector (220V/240V switchable) is provided near the front panel. In this case 220V is factory-preset. If you want to change into 240V line, consult your nearest Yamaha dealer.

E. Fuse

10 amp, 250 volt, type AGC (3AG); U.S. and Canadian models only. 5 amp, 250 volt; other territories' models. Fuse should always be replaced with same size and type. If the fuse blows consistently, the amplifier should be checked by a qualified Yamaha service technician.

*Paralleled inputs are not the same as monaural mode. See pages TWO 1 and SIX 17 for use of internal STEREO/MONO switch.

** The rear panel shown here is subject to U.S. specifications.

SECTION TWO 1

INTRODUCTION

The P2100 is not just another power amplifier; it is an exciting new approach to high accuracy sound. Yamaha's leadership is clearly demonstrated by the P2100's professional features, sophisticated design, and uncompromising performance.

CALIBRATED INPUT ATTENUATORS

The P2100 has log-linear INPUT ATTENUATORS. The input attenuators are marked in 22 calibrated dB steps, detented for extra accuracy. The attenuators provide a smooth, noise-free transition from the highest to the lowest audio level. dB-calibrated input attenuators have numerous advantages: on the road, they allow predictable and repeatable setups; in commercial sound applications, they allow easy, accurate input sensitivity adjustments; in studios or discos, they let operators simultaneously adjust the level of two channels, or two programs on separate amplifiers, with precise tracking.

INPUT AND OUTPUT CONNECTIONS

INPUT CONNECTORS for each channel include one "male" and one "female" XLR connector (unbalanced) plus two parallel phone jacks. This provides the flexibility necessary for convenient bridging to another amplifier, as well as for adapter-free connection to almost any mixer. A POLARITY switch allows either pin 2 or pin 3 of the XLR to be chosen as the "hot" lead, satisfying DIN/JIS or USA standards. On U.S., Canadian and Australian models outputs are standard five way binding posts, usable with high current "banana" plugs or direct wired connections. Other territories' model binding posts accept direct wired connections.

MONAURAL OPERATION

The P2100 may be converted to a monaural "super amplifier" with an internal STEREO/MONO switch. This creates a transformerless balanced output, the speaker load "bridged" across the "hot" terminals of both channels. In this mode, the P2100 is suitable for driving almost any load, including highly reactive constant-voltage commercial speaker lines. With a full 200 watts into 16 ohms, the P2100 in mono mode eliminates the need for several smaller amplifiers.

PERFORMANCE

The P2100's performance is as impressive as its features. At a sustained output of 95 watts into 8 ohms (for each channel), there is plenty of punch to reproduce the powerful peaks essential to clean studio monitoring. The ability to sustain full power output also makes the P2100 an unbeatable choice for live rock or disco sound systems, where an amplifier can really "cook" all night long. Power alone is no virtue; the P2100 has ultra-low distortion, less than 0.05% THD at full rated power — the kind of low distortion that is undetectable by even the most critical listeners.

A high damping factor of better than 250 at frequencies below 1kHz reduces the tendency for speaker cone overshoot, giving tighter and better defined bass response. On the other end, the P2100's frequency response extends well beyond 100kHz,

enabling it to accurately reproduce the most complex musical waveforms — even the tortuous output of today's synthesizers. However, high frequency response has not been achieved at the expense of stability; in fact, the P2100 is rock steady. Even when connected to highly reactive multi-speaker loads, there is no tendency to shut down or "take off" into spurious oscillation.

MECHANICAL CONSIDERATIONS

The P2100 is constructed to withstand the high "G" forces encountered on the road. The P2100's solid front panel mounts in any standard 19-inch rack, and weighs a modest 31 pounds (14kg). Front panel controls are recessed to avoid damage or accidental setting changes, and are further protected by a pair of sturdy carrying handles. Inside and out, the P2100 is extremely reliable. Still, should service ever be required, the unit is designed for easy access. Massive side-mounted heat sinks are designed for efficient cooling, making fans unnecessary in all but the most severe thermal operating conditions. Four non-conductive feet ensure proper air flow when the amplifier is shelf mounted, and avoid inadvertent ground loops. Multiple protection circuits make the amplifier nearly abuse proof and eliminate the need for troublesome DC power supply fuses.

SECTION THREE 1

GENERAL SPECIFICATIONS

Power Output Per Channel: (Refer to Figure 3)

85 watts continuous average sine wave power into 8 ohms with less than 0.05% THD, over a bandwidth of 20Hz to 20kHz, both channels driven.

95 watts continuous average sine wave power into 8 ohms with less than 0.05% THD, at 1kHz, both channels driven.

Power Output At Clipping: (Refer to Figure 4)

110 watts continuous average sine wave power into 8 ohms at 1kHz, both channels driven.

Frequency Response: (Refer to Figure 5)

+0dB, -0.5dB, 20Hz to 50kHz.

Total Harmonic Distortion: (Refer to Figures 6 & 7)

Less than 0.01% @ 50 watts, 8 ohms, 1kHz.

Less than 0.02% @ 50 watts, 8 ohms, 20Hz to 20kHz.

Intermodulation Distortion: (Refer to Figure 8)

Less than 0.03% using frequencies of 70Hz and 7kHz, mixed in a ratio of 4:1, single channel power output of 75 watts into 8 ohms.

Input Sensitivity:

An input of 0dB* (0.775V), ± 0.5 dB, produces an output of 95 watts into 8 ohms, INPUT attenuator set for maximum level.

Input Impedance:

25k-ohms, minimum (unbalanced).

Damping Factor: (@ 8 ohms) (Refer to Figure 9)

Greater than 250 at any frequency from 20Hz to 1kHz; greater than 70 at any frequency from 20Hz to 20kHz.

Actual Output Impedance: (Refer to Figure 10)

Less than 0.04 ohms, from 20Hz to 10kHz.

Hum and Noise:

At least 110dB signal-to-noise ratio (I.H.F./A.S.A. No. Z24.3-1944).

Rise Time:

3.0 microseconds, or better (10%-90% of 1 volt @ 1kHz square wave output).

Slew Rate:

30 volts per microsecond, or better (at 30 watts into 8 ohms, 200kHz square-wave input).

Channel Separation: (Refer to Figure 11)

At least 82dB at 1kHz, at least 70dB at 20kHz.

Phase Shift: (Refer to Figure 12)

20Hz to 20kHz, ± 10 degrees.

**In these specifications, when dB represents a specific voltage, 0dB is referenced to 0.775V. "dB" is a voltage level, whereas "dBm" is a power level. 0dBm is referenced to 1mW (0.775V driving a 600-ohm termination). For example, when 12.3V is fed to a high impedance, the level is designated "+24dB." When +24dB (12.3 volts) drives a 600-ohm termination, the level is designated "+24dBm." The level in "dB" is specified, wherever applicable, to avoid confusion when the input is fed by various low and high impedance sources. See the APPENDIX beginning on Page EIGHT 1 for a further discussion of dB.*

Offset Voltage:

Less than ± 10 mV DC.

Unit Step Function Response:

See scope photo (Figure 27, Page FOUR 4), and discussion (Page FOUR 6).

Thermal Characteristics:

Massive black anodized heat sinks are thermally joined with the chassis, thereby utilizing the entire amplifier as a heat sink.

Protection Circuits:

Thermal warning light turns on when heat sink temperature reaches 100 degrees Centigrade. A *self-resetting* thermal switch shuts down the AC power if the power transformer winding temperature reaches 130 degrees Centigrade. See Page SIX 13 for power overload circuit discussion.

Turn On/Turn Off Characteristics:

There is no turn off transient; the turn on transient is minimal (see Page SIX 13). Warm up time is less than 0.2 seconds.

Power Requirements:

For the U.S. and Canadian models: AC, 117 Volts nominal, 50-60Hz (105V min., 135V max.); 3.9 amperes maximum at 120V AC; 470 volt-amperes maximum at 120 Volts; approximately 38 volt-amperes at idle.

For other territories' models: 700 Watts, 220 or 240 Volts AC nominal, 50-60Hz.

Efficiency: (Refer to Figure 13)

As high as 63%.

Input Connectors:

One "male" and one "female" XLR connector in parallel, pin 2 "hot," pin 3 connected to pin 1 (shield); switchable for pin 3 "hot." XLR's are unbalanced and in parallel with two tip-sleeve (standard) phone jacks.

Output Connectors:

Standard 3/4-inch spacing, "5-way" binding posts (U.S., Canadian and Australian models). Conventional binding posts (other territories' models).

Indicators:

One "power ON" indicator LED, one "THERMAL Overload" indicator LED.

Controls:

22-position, log-linear, detented and dB-calibrated INPUT ATTENUATORS (one per channel) attenuate input signal in 2dB steps from 0dB attenuation to -34dB, then steps of -37dB, -42dB, -50dB, infinity; Power (ON-OFF) switch; INPUT POLARITY switches.

Fuse:

AGC (3AG) type, 10-amp for the AC line input. (U.S. and Canadian models). 5 amp for the AC line input (other territories' models).

Dimensions:

Mounts in a standard 19-inch (48cm) rack. 5-1/4" high (13.4cm); maximum depth behind front panel is 11-1/4" (28.5cm); maximum depth including front handles 12-5/8" (32.0cm).

Weight:

31 pounds (14kg).

Color:

Semi-gloss black.

THREE 2

MONAURAL MODE SPECIFICATIONS

Power Output: *(Refer to Figure 14)*

200 watts continuous average sine wave power into 16 ohms with less than 0.05% THD, 20Hz to 20kHz.

Power Output At Clipping: *(Refer to Figure 15)*

230 watts continuous average sine wave power into 16 ohms at 1kHz.

Frequency Response: *(Refer to Figure 16)*

+0dB, -1dB, 20Hz to 50kHz.

Total Harmonic Distortion: *(Refer to Figures 17 & 18)*

Less than 0.01% @ 200 watts into 16 ohms at 1kHz.

Intermodulation Distortion:

Less than 0.05% using frequencies of 70Hz & 7kHz, mixed in a ratio of 4:1, at a power output of 100 watts into 16 ohms.

Input Sensitivity:

An input of 0dB (0.775 Volts), ± 0.5 dB, produces an output of 200 watts into 16 ohms (INPUT attenuator set for minimum attenuation, maximum level).

Input Impedance:

25k-ohms minimum (unbalanced)

Damping Factor: *(@ 16 ohms) (Refer to Figures 19 & 20)*

Greater than 400 at any frequency from 20Hz to 1kHz; greater than 200 at any frequency from 20Hz to 20kHz.

Hum and Noise:

At least 110dB signal-to-noise ratio (I.H.F./A.S.A. No. Z24.3-1944).

Slew Rate:

50 volts per microsecond, or better, at 30 watts into 16 ohms, 200kHz square wave input.

NOTE: All performance specifications are made on U.S. and Canadian models at an AC line voltage of 120 Volts $\pm 1\%$, using a $\pm 1\%$ nonreactive load resistor at an ambient room temperature of 25-degrees Centigrade. Also effective for other territories' models.

SECTION FOUR 1

PERFORMANCE GRAPHS & A DISCUSSION OF SPECIFICATIONS

NOTE: In the discussion beginning on Page FOUR 5, references to specific specifications assume normal stereo operation (not mono operation) unless otherwise indicated.

Normal (Stereo) Graphs

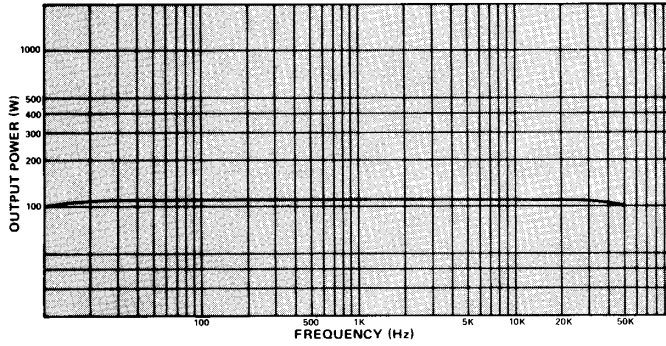

Fig. 3 - Power Bandwidth vs Load Impedance

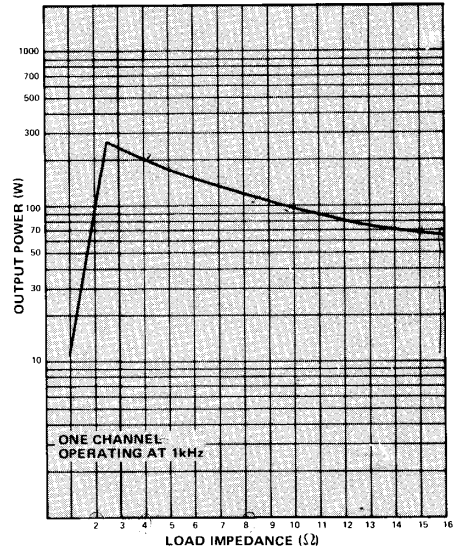

Fig. 4 - Load Impedance vs Output Power

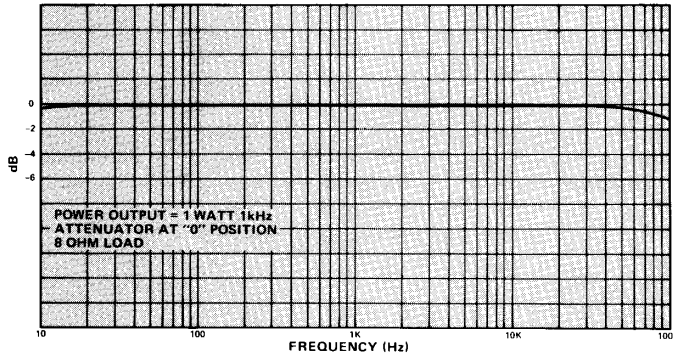

Fig. 5 - Frequency Response vs Load

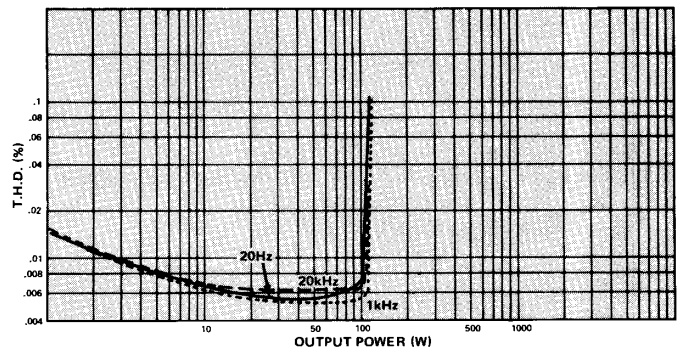

Fig. 6 - T.H.D. vs Output Power at 8Ω Load Impedance (both channels driven)

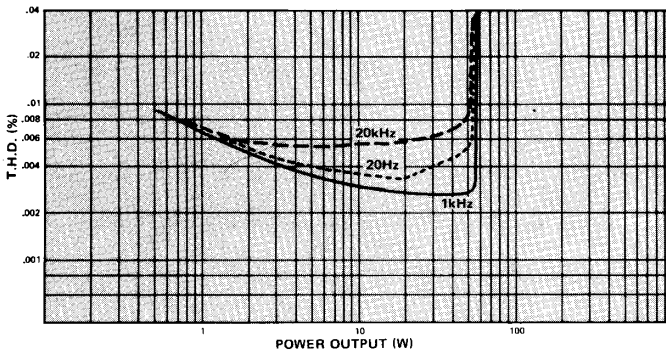

Fig. 7 - T.H.D. vs Output Power at 16Ω Load Impedance (both channels driven)

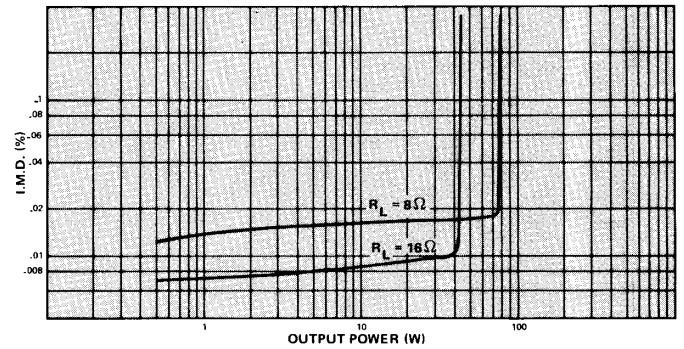

Fig. 8 - Intermodulation Distortion vs Power Output at 8 and 16Ω Load Impedance

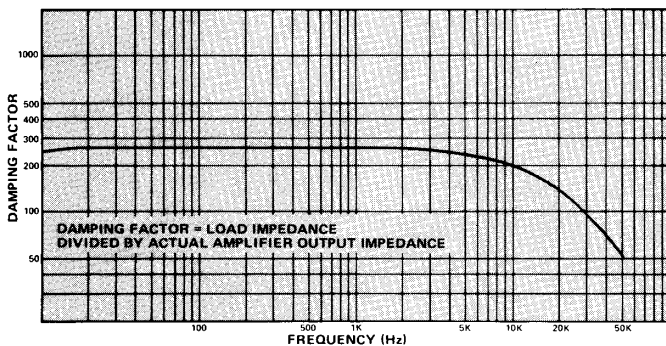

Fig. 9 - Damping Factor vs Frequency at 8Ω Load Impedance

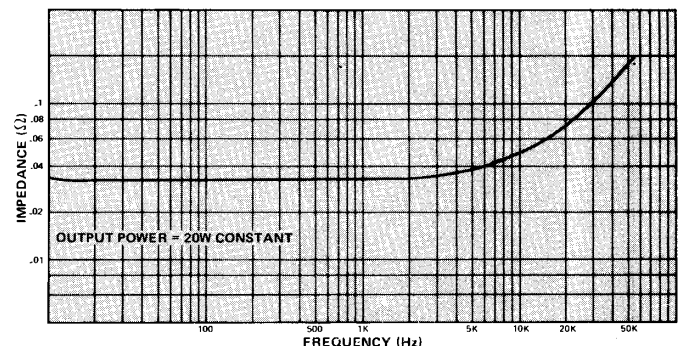

Fig. 10 - Actual Output Impedance vs Frequency

FOUR2

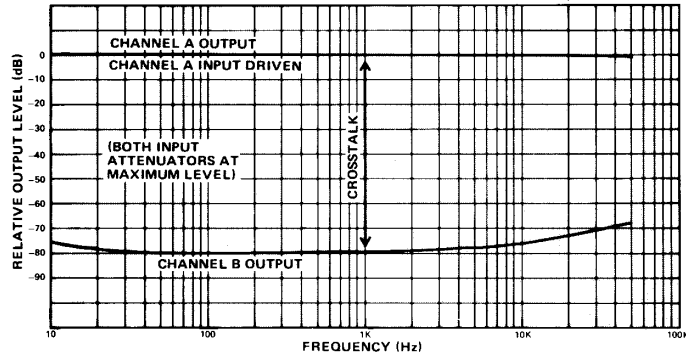

Fig. 11 - Crosstalk (Channel Separation)

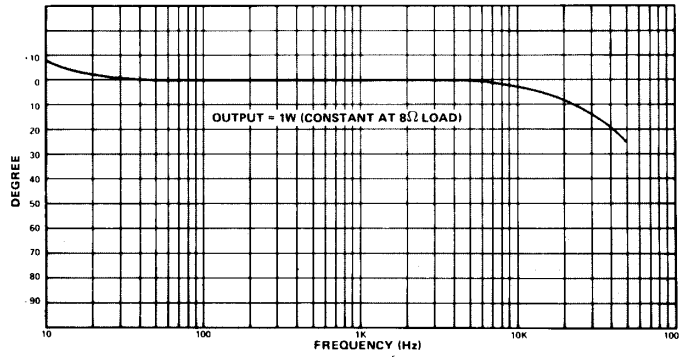

Fig. 12 - Phase Response vs Frequency

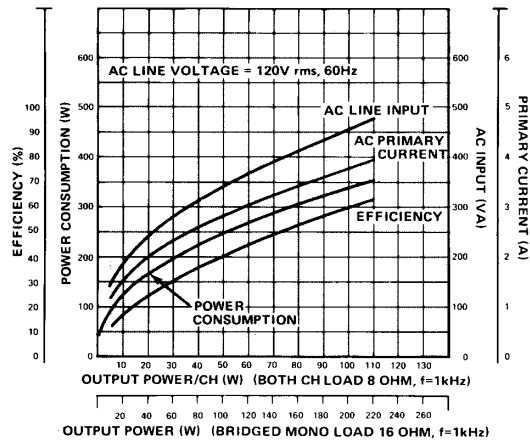

Fig. 13 - Power Consumption

Mono Mode Graphs

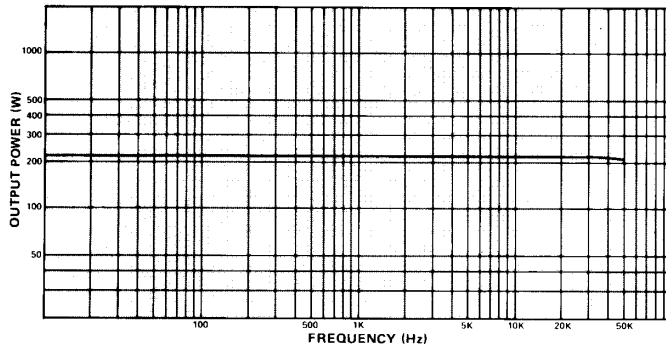

Fig. 14 – Power Bandwidth vs Frequency (Mono Mode) at 16Ω Load Impedance

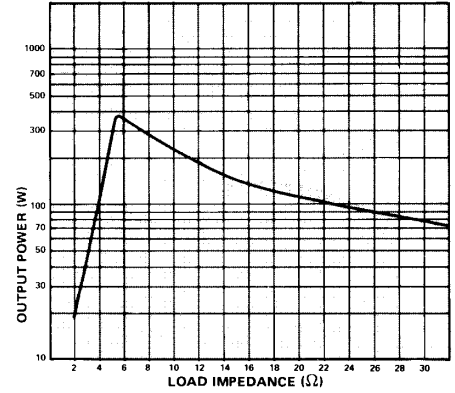

Fig. 15 – Load Impedance vs Output Power (Mono Mode) at 0.1% T.H.D., 1kHz

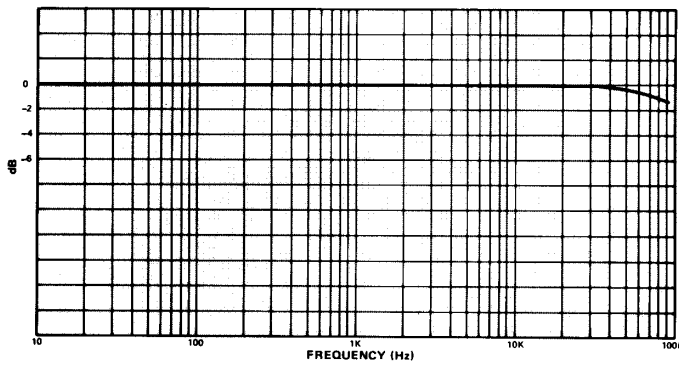

Fig. 16 – Frequency Response (Mono Mode) at 16Ω Load Impedance

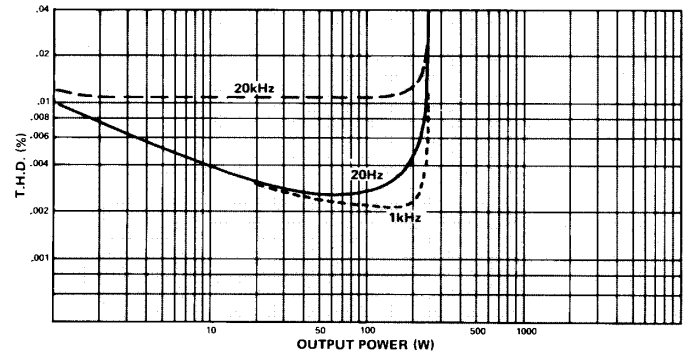

Fig. 17 – T.H.D. vs Power Output (Mono Mode) at 16Ω Load Impedance

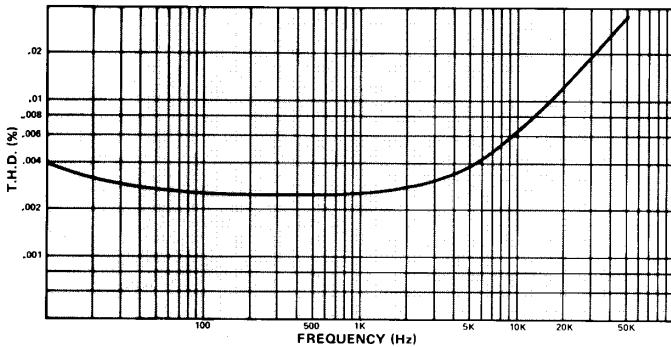

Fig. 18 – T.H.D. vs Frequency (Mono Mode) at 16Ω Load Impedance

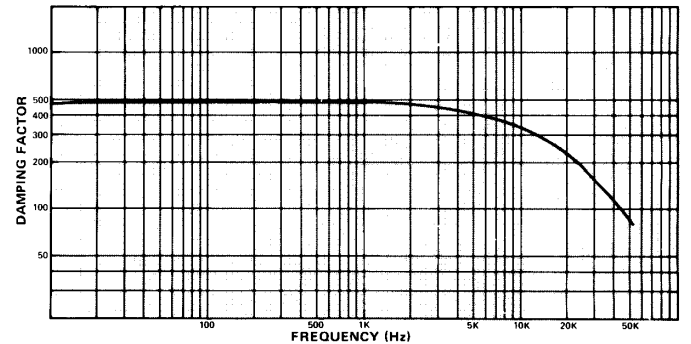

Fig. 19 – Damping Factor vs Frequency (Mono Mode) at 16Ω Load Impedance

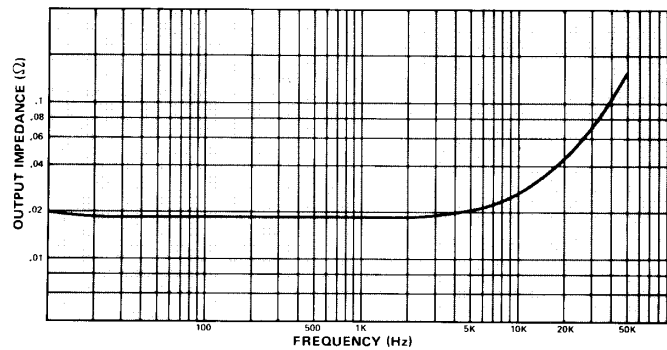

Fig. 20 – Actual Output Impedance (Mono Mode) vs Frequency

FOUR4

The following are actual oscilloscope photographs made by an independent testing laboratory. The close vertical alignment of input and output traces in Fig. 21 through 23 depicts very low phase shift, so the amplifier will not alter musical wave shapes.

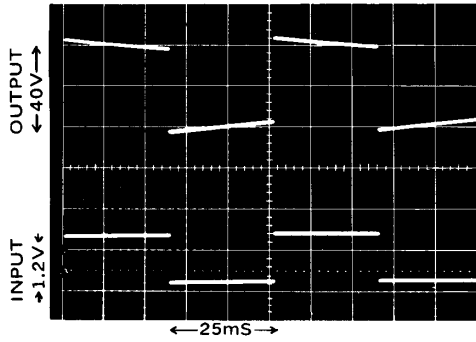

Fig. 21 - 20Hz Square-Wave Response
The output waveform displays very respectable low frequency response. The slight tilt shows a DC gain of unity, which prevents damage to speakers in the event any DC offset is fed to the amplifier input.

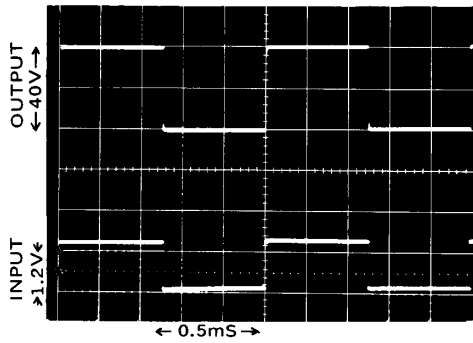

Fig. 22 - 1,000Hz Square-Wave Response
Near perfect response is evident in the duplication of the input waveform by the output waveform. There are no "squiggles" or spikes, meaning there is no ringing or overshoot.

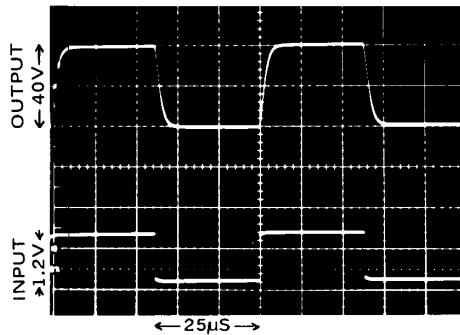

Fig. 23 - 20,000 Hz Square-Wave Response
The extremely fast and symmetrical rise and fall times of the amplifier are evident, demonstrating the ability to reproduce accurately musical waveforms and harmonics well beyond the range of human hearing.

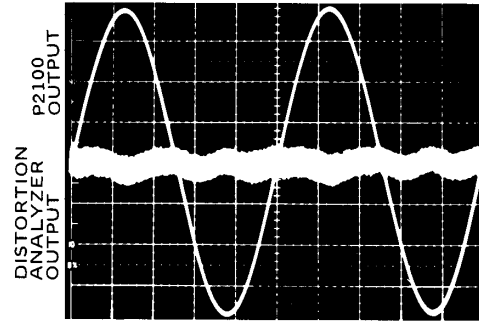

Fig. 24 - 1,000Hz Sine Wave, Shows with Highly Magnified Noise & Distortion Components
Even at full 95 watt output (8 ohms), the P2100's distortion is so low that it is almost buried in the noise, which is some 110dB below the sine wave output. The sine wave is clean and symmetrical.

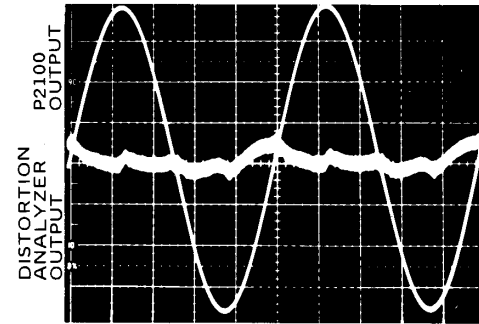

Fig. 25 - 20,000Hz Sine Wave, Shown with Highly-Magnified Noise & Distortion Components
Even at 20kHz, the P2100 produces 95 watts continuous output with low distortion and symmetrical reproduction. As in Fig. 11, the noise (magnified here) is actually some 110dB below the sine wave.

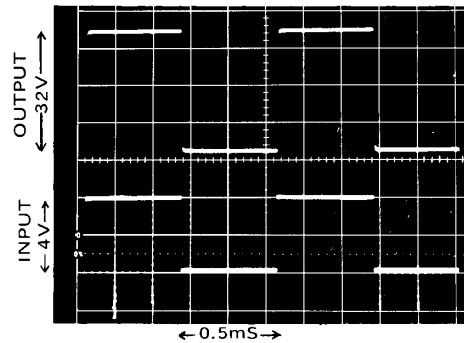

Fig. 26 - Square-Wave Response into a Highly-Inductive Load (at 1kHz)
The P2100's ability to maintain a sharply defined square wave output into a reactive load demonstrates stability under the worst conditions. There is still a complete lack of unwanted ringing, as well as virtually unmeasurable phase shift.

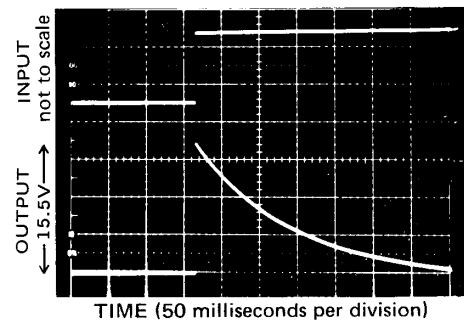

Fig. 27 - Unit-step Function Response

POWER OUTPUT

Types of Power Ratings

Peak power refers to the maximum undistorted power output of an amplifier. Most amplifiers cannot sustain their peak power ratings for long periods of time without external cooling fans. Because there are many different methods of rating an amplifier's peak power, it is hard to objectively compare the peak power ratings of two amplifiers. The peak power rating is primarily useful for determining an amplifier's ability to reproduce the peaks and transients in a musical program, peaks which may be 20dB or more above the average power level. The ability to accurately reproduce these high power peaks in a musical program is one of the most important advantages of the P2100 as compared to a smaller power amplifier.

"RMS" power is actually a misnomer for *average power*. Average power is usually measured with a sine wave input signal, and is equal to the amplifier's rms output voltage squared and then divided by the load impedance (see Appendix). Because rms voltage is used in the formula, the resulting power rating is commonly called "rms power." To be more accurate, the P2100 is rated in watts of "continuous average sine wave power," which is calculated from the rms voltage across a known load.

Since the P2100 is a *professional* power amplifier, not sold for home hi-fi use, it is not required to meet the power rating standard set by the FTC (Federal Trade Commission), a standard meant for *consumer* power amplifiers. However, the P2100 is measured under severe conditions which stimulate the most demanding *professional* usage. Thus, the P2100 would easily meet the FTC ratings for consumer amplifiers. In addition, the P2100 user has the benefits of professional features and reliability.

Reasons for a High Power Amplifier

An interesting characteristic of the human ear is described by the "Weber-Fechner" law. In its general form, the law applies to all our senses:

The amount of additional stimulus needed to produce a perceptible change is dependent on the amount of stimulus already present.

In mathematical terms, the Weber-Fechner law suggests that the human ear responds to changes in sound level in a logarithmic manner. More simply this means that *for a sound to seem twice as loud*, it requires approximately *ten times as much acoustic power*, and therefore ten times as much amplifier power. Thus, the P2100's high power output capabilities are extremely valuable.

One of the other benefits of high power output is the ability of the amplifier to easily reproduce the peak power transients, which may be 100 times the average program power, or even more. This subject is discussed further on Pages FIVE 2 and FIVE 4.

Power Output at Clipping (Refer to Figure 4)

This rating indicates the maximum peak output capabilities of the P2100 at 1kHz with an 8-ohm load.

Power Output versus Load

Within its maximum limits, the P2100 acts like a perfect voltage source (see Appendix). That is, its power output rises with decreasing load impedance. When the load impedance drops below 2.5 ohms, the P2100's protection circuits begin to limit the power, resulting in the curve shown in Figure 4 (normal operation) and Figure 15 (mono operation).

DISTORTION (Refer to Figures 6, 7, 8, 17 and 18)

The P2100 is designed to have the lowest possible distortion. There are many different forms of distortion, however, and comprehensive distortion ratings offer a means to compare the performance of different amplifiers.

Harmonic distortion is characterized by the appearance at the amplifier output of *harmonics* of the input waveform which were not present in the *original* input waveform. *Total Harmonic Distortion*, or T.H.D., is the sum total of all of these unwanted harmonics expressed as a percentage of the total signal.

Harmonic distortion in an amplifier can be created in any of several ways. The T.H.D. rating of a power amplifier refers to creation of unwanted harmonics by the amplifier during "linear" operation (normal input and output levels, impedances, etc.). Harmonic distortion is also created by "clipping," a form of "non-linear" operation which occurs when the signal level at an amplifier's input is high enough to drive the amplifier beyond its rated maximum output. The amplifier, in attempting to reproduce this signal, reaches its maximum output voltage swing before it reproduces the top of the signal waveforms. Since the output voltage cannot rise any farther, the tops of the waveform are "squared off," or clipped, as that shown in Figure 65, Page SEVEN 1. Clipping distortion adds odd upper harmonics (3rd, 5th, etc.) to the original signal. Input clipping, where the input stage of the amplifier is overdriven by a high level input signal, would be similar. The P2100 has wide input headroom and extremely high peak power output capabilities (headroom) to help avoid the problems of clipping distortion.

Another form of harmonic distortion that occurs in some power amplifiers is called *crossover distortion*. * Crossover distortion is caused by improper bias in the output transistors of an amplifier. The *amount* of crossover distortion stays the same whether the signal is large or small, so the *percentage* of distortion goes down as the signal level goes up. Thus, an amplifier with crossover distortion may sound relatively distortion free at high output levels, yet sound "fuzzy" at low levels. Some amplifiers have internal adjustments which enable a service technician to control the amount of output transistor bias, and therefore control the distortion. The P2100 has automatic biasing circuitry which needs no adjustment and avoids crossover distortion under all operating conditions.

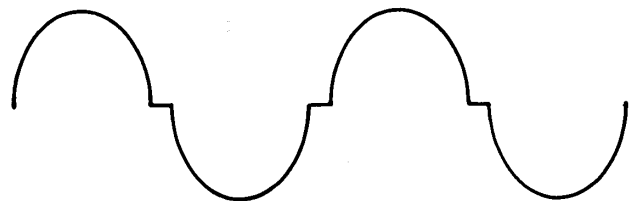

Fig. 28A — Large Amplitude Sine Wave with Crossover (notch) Distortion.



Fig. 28B — Smaller Amplitude Sine Wave with same amount (higher %) of Crossover (notch) Distortion.

*"Crossover," in this case, refers to the transition between the positive half and the negative half of the output voltage waveform in a "push pull" class B or AB power amplifier; it has nothing to do with the crossover used to divide frequencies in a speaker system. See Figure 28.

FOUR6

Intermodulation distortion, or I.M., is characterized by the appearance in the output waveform of frequencies that are equal to sums and differences of integral multiples of two or more of the frequencies present in the input signal. The difference between intermodulation distortion and harmonic distortion is that two or more different frequencies must be present to produce intermodulation distortion, and that intermodulation distortion products may not be harmonically related to the original frequencies. (Only one frequency is needed for harmonic distortion to appear.) Like its harmonic distortion figure, the intermodulation distortion in the P2100 is low enough to be virtually inaudible even in the most critical situations.

Dynamic Frequency Response Shift is related to both harmonic and intermodulation distortion. When high level low and high frequency signals are present in the same waveform, the high frequency signals "ride" on top of the low frequency waveforms (See Figure 65, Page SEVEN 1). If amplifier headroom is inadequate, the low frequencies may "push" the high frequencies above the output limits of the amplifier, clipping them off the waveform (Figure 65C). The low frequencies may remain unaltered, but the high frequencies are severely reduced. At the same time, harmonics of the high frequencies are produced which add to the super high frequency content of the signal. Thus, along with the distortion created by the clipping, the frequency response of the original signal is drastically altered. This type of distortion can be reduced by increasing system headroom (using a more powerful amplifier like the P2100), and by bi-amplifying the system as discussed on Page SEVEN 1.

The extremely low distortion figures of the P2100 indicate its overall quality and mean that its sound will be precise and natural.

FREQUENCY RESPONSE (Refer to Figures 5 & 16)

The *frequency response* of the P2100 describes the variation in its output signal level with frequency when the input signal is held constant. The extremely "flat" frequency response curve of the P2100 is an indication of its overall quality and its ability to respond to upper and lower harmonics of signals all the way to the extremes of the audio spectrum.

Because good stability is necessary for some types of commercial sound applications, notably constant-voltage commercial sound speaker lines, some manufacturers restrict frequency response or allow relatively high distortion in return for increased amplifier stability. The P2100, on the other hand, has excellent frequency response and ultra-low distortion, yet is inherently stable under the most difficult loads, even in the "mono" mode.

The frequency response of the P2100 has been intentionally limited, however, at very low, subsonic frequencies. Because of this, severe low frequency transients, or DC offset, appearing at the input to the P2100 are unlikely to damage a speaker load. Other amplifiers which are DC coupled throughout may have a "flatter" subsonic frequency response, but this makes them capable of amplifying dangerous DC input voltages or sub-audio transients and delivering them (at high power) to a speaker.

OFFSET VOLTAGE

This specification indicates the amount of DC voltage naturally present at the output of the amplifier. A high DC voltage could damage the loudspeaker load;

the $\pm 10\text{mV}$ (10 one-thousandths of a volt) level from the P2100 is insignificant.

UNIT STEP FUNCTION RESPONSE (Refer to Figure 27)

A unit step function is like the leading edge of a square wave; it goes up, but never comes down. The response to this input indicates the output of the P2100 for a DC input signal which might come from a faulty direct coupled preamplifier, or mixer. Note that the P2100 will not reproduce a DC voltage fed to its input, thus adding an extra measure of loudspeaker protection.

POWER BANDWIDTH (Refer to Figures 3 & 14)

The *power bandwidth* of the P2100 is a measure of its ability to produce high power output over a wide frequency range. The limits of the power bandwidth are those points where the P2100 can only produce 1/2 the power that it can produce at 1000Hz. While the frequency response is measured at relatively low power output (1 watt), the power bandwidth is measured at the P2100's full power output (before clipping). The power bandwidth of the P2100 is quite "flat," and extends to 200kHz, well beyond the limits of the audio spectrum.

The wide power bandwidth of the P2100 means that it can reproduce high level upper harmonics of a signal as easily as it can reproduce mid-range fundamentals. It means that you get full power performance from the P2100 over the entire audio frequency spectrum. This is especially important when the amplifier is called upon to reproduce musical material with high energy over a wide frequency range, such as rock and roll.

PHASE RESPONSE (Refer to Figure 12)

The *phase response* of the P2100 is a measure of the amount of time delay it adds to different frequencies. An amplifier with perfect phase response would introduce equal time delay at all frequencies reproduced. The P2100's worst case phase shift of -10 degrees at 20kHz corresponds to a 1.4 microsecond (1.4 millionths of a second) delay period which is insignificant in even the most critical audio applications.

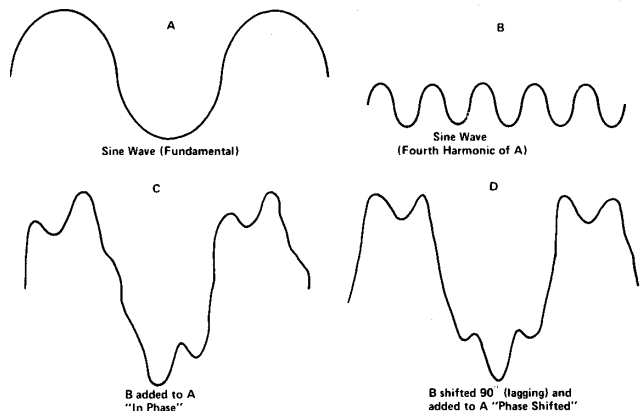

Fig. 29 — Waveform of Amplifier with Poor Phase Response.

An amplifier with poor phase response would change the shape of a waveform that was made up of a fundamental frequency and several harmonics by delaying each harmonic differently. The effect might be similar to that shown in Figure 29.

CHANNEL SEPARATION (Refer to Figure 11)

This specification indicates the output from one channel when a signal is fed to the other channel. The P2100's channel separation is very good, which means that even critical stereo programs will be unaffected by crosstalk between channels.

HUM AND NOISE

Hum or noise from a power amplifier disrupts a program, and is irritating to a listener. Hum and noise could be considered a form of distortion. The P2100's hum and noise are so low that they are completely inaudible under any normal listening circumstances.

RISE TIME

Rise time is a measurement of the amount of time an amplifier requires to respond to a square wave at a specified frequency. The rise time of an amplifier is an indication of its frequency response. A fast rise time corresponds to a wide frequency response. The P2100's rise time specification is measured with a 1000Hz square wave output signal of one volt peak-to-peak amplitude. The rise time is the time the amplifier requires to change from 10% (0.1 volt) to 90% (0.9 volt) of its output. The first and last 10% are normally not included in the test because any slight non-linearities that occur in this portion of the test signal or the amplifier could lead to measurement error. Thus, a 10%-90% figure improves measurement accuracy.

SLEW RATE

Slew rate is a measure of the ability of the amplifier to follow a fast rising waveform at higher frequencies and higher power outputs than the rise time measurement. The P2100's slew rate is measured with a 200kHz square wave input signal, at 30 watts output power into 8 ohms (stereo operation).

It might seem reasonable to assume that the fastest slew rate for an audio waveform occurs at 20kHz. However, this is not the case. When one frequency is superimposed upon another, the combined waveform has a slew rate that is greater than the slew rate of either signal by itself. The actual value of the slew rate of one of these waveforms, or of any waveform, depends not only on the frequency, but on the amplitude of the waveform as well. Thus, the criteria for a good slew rate specification, which indicates that an amplifier can reproduce these combination waveforms, varies with the maximum power output capability of the amplifier. The higher the power, the higher the required slew rate. With a 30 volts/microsecond slew rate, the P2100 can easily reproduce even the most extreme audio waveforms at its full power output.

INPUT IMPEDANCE

The *input impedance* of the P2100 is high enough to allow it to be used with most semi-pro devices, or to be used as a "bridging" load for a 600-ohm source. Page SIX 2 details input impedance and level matching for the P2100.

INPUT SENSITIVITY

The P2100's *input sensitivity* indicates the input drive voltage needed for the P2100 to produce 95 watts into 8 ohms with input attenuators adjusted to maximum clockwise rotation for minimum attenuation.

PROTECTION CIRCUITS AND THERMAL CHARACTERISTICS

See the discussions under INSTALLATION, on Page SIX 13.

GAIN

Gain is the ratio of the P2100's output voltage to its input voltage. Maximum gain occurs when the input attenuators are set for minimum attenuation. If the input and output voltage are specified in dB, the voltage gain is equal to the difference of the two dB numbers. As stated under INPUT SENSITIVITY, an input voltage of 0dB (0.775 volts) produces an output

power of 95 watts into an 8-ohm load. 95 watts into 8 ohms implies an output voltage of 27.6 volts, which corresponds to +31dB. dB is referenced to 0.775 volts, as used in this manual. Thus, the voltage gain of the P2100, with its input attenuators set for minimum attenuation, is 31dB (+31dB - 0dB = 31dB).

OUTPUT IMPEDANCE (Refer to Figures 10 & 20)

The *output impedance* of the P2100 is extremely low. Thus, within its operating limits, the P2100 is a good approximation of a perfect voltage source and will deliver increasing power levels into lower impedance loads in a linear fashion according to Ohm's law. The appendix discusses Ohm's law and the concept of a perfect voltage source.

DAMPING FACTOR (Refer to Figures 9 & 19)

Damping factor is a term that is derived by dividing the load impedance (speaker or other load) by the amplifier's output impedance. Thus, a high damping factor indicates a low output impedance at a specified load.

The cone/voice-coil assembly of a loudspeaker gains inertia during its back and forth movements. This inertia can cause it to "overshoot," that is, to continue movement in one direction, even when the amplifier is trying to pull it back in the other direction. An amplifier with a low output impedance can "damp" (reduce) unwanted loudspeaker motions, as explained below.

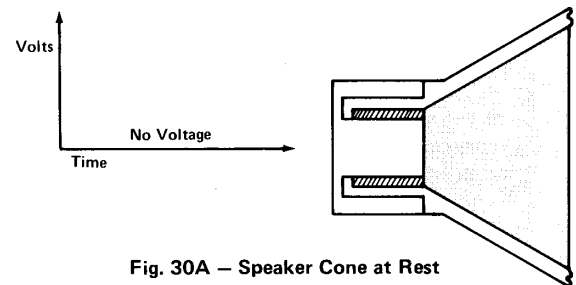

Fig. 30A - Speaker Cone at Rest

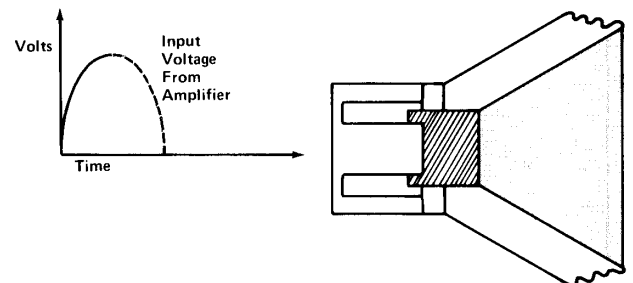

Fig. 30B - Speaker Cone moved outward by Positive-Going Voltage from Amplifier.

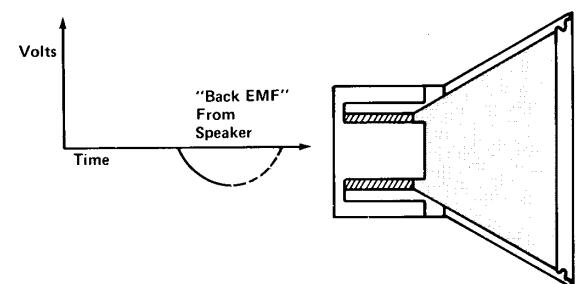

Fig. 30C - Voltage from Amplifier has dropped to Zero but Speaker Cone has moved back PAST its rest position (overshoot) and is producing a voltage of its own: "Back EMF"

FOUR8

During the "overshoot" movement, the voice coil of the loudspeaker interacts with the loudspeaker's magnetic assembly to produce a voltage called "back E.M.F." (electromotive force). This action is similar to the operation of a dynamic microphone. If the amplifier's output impedance is low, this "back E.M.F." voltage is shunted through the amplifier's output circuits to ground, and back to the voice coil. Since the path from the voice coil, through the amplifier's output circuits, and back to the voice coil is a complete circuit, a current flows in the voice coil. This current causes the voice coil to act like an electro-magnet; the electro-magnet interacts with the magnetic assembly of the loudspeaker, and the unwanted overshoot is reduced by a magnetic braking action.

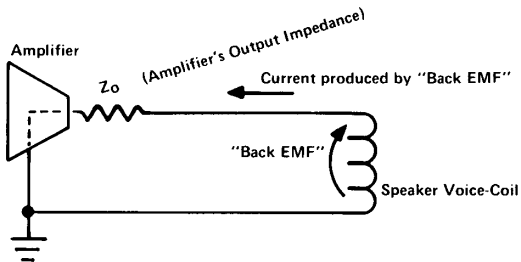

Fig. 31 – Current produced by "Back EMF" follows path through Amplifier's Output Impedance to speaker-coil.

If the amplifier's output impedance is low, considerably less than the impedance of the loudspeaker voice coil, this damping action is limited only by the resistance of the voice coil combined with the resistance of the speaker lead wires. While the value of a high damping factor in reducing cone overshoot is disputed, the P2100's high damping factor is evidence of good overall engineering design.

THE DISTINCTION BETWEEN PROFESSIONAL AND HI-FI EQUIPMENT

In most applications, a variety of auxiliary equipment will be connected to the P2100, including: mixers, tape machines, compressors, graphic equalizers, echo, time delay, and reverb units, and just about any other audio electronics imaginable. Regardless of the function of auxiliary equipment, it will undoubtedly fall into one of two general categories, professional type or hi-fi type. The following criteria place most "semi-pro" equipment in the hi-fi classification.

The distinction between professional and hi-fi equipment is important primarily because it affects the way it will be used with the P2100. Brand name, size, panel colors, durability and subtleties in function are *not* the significant differences. What matters is that professional equipment and hi-fi equipment usually operate at different input and output levels, and require different source and load impedances to function properly. The P2100 is designed to function well with other professional equipment, although it has high enough input impedance and sensitivity to yield excellent results with hi-fi type equipment if a few precautions are observed. These precautions are outlined in the Installation section of the manual. The following paragraphs explain how the specific requirements differ for professional and hi-fi (or semi-pro) equipment.

IMPEDANCE

The inputs of a piece of professional audio equipment are usually designed to be driven from a low impedance source, nominally 150 to 600 ohms, and its outputs will drive low impedance loads (600 ohm or higher). Power amplifier *outputs* are not considered in this discussion. Professional input and output circuits may be unbalanced, but they are often transformer isolated (balanced or floating), and use dual conductor shielded cables, with 3-pin XLR type connectors or Tip/Ring/Sleeve phone plugs.

The P2100's inputs are unbalanced due to cost and adaptability factors. Internally balancing the P2100's inputs would require two matched input transformers with heavy shielding to avoid hum pickup from the P2100's power transformer. Induced hum in low level circuits, especially in low level transformers, can be a problem with any power amplifier or other high current device, such as a DC power supply. High quality external transformers with less shielding can achieve the same results with a substantial cost savings. In addition, the user can choose the optimum impedance ratio for a given situation, increasing the P2100's adaptability. Either the "matching transformer box" or "step up transformer box" described on Pages SIX 3, and SIX 4 are suitable, so long as they are kept several inches away from the P2100.

Hi-fi and semi-pro equipment generally is designed to be driven from a 5,000-ohm or lower impedance source, and its output will drive 10,000-ohm or higher impedance loads. Hi-fi input and output circuits are usually unbalanced, and use single conductor shielded cables with 2-conductor connectors, either standard phone plugs or phono plugs, also called RCA or pin plugs.

Occasionally, the inputs of a piece of hi-fi or semi-pro equipment are professional XLR connectors which have been converted to a 2-wire, unbalanced circuit by internally connecting either pin 2 or pin 3 to pin 1.

The nature of unbalanced, balanced, and floating circuitry is discussed further in the Appendix of this manual. For the purpose of this discussion, the most significant point is that an unbalanced circuit is somewhat more susceptible to hum and noise, especially if there is any irregularity in the grounding system.

NOTE: THERE IS NO CORRELATION BETWEEN "BALANCED" OR "FLOATING" AND CIRCUIT IMPEDANCE.

Low impedance and high impedance are relative terms. A 150- to 250-ohm microphone is considered low impedance, whereas a 10,000-ohm mic is considered high impedance. A 600-ohm line is considered low impedance, whereas 10,000-ohm, 50,000-ohm or 250,000-ohm lines are all considered high impedance. Sometimes, mics and lines with an impedance of 600 ohms to about 2000 ohms are considered "medium" impedance.

NOTE: THE IMPEDANCE OF A CIRCUIT SAYS NOTHING ABOUT ITS LEVEL.

While the exact transition between low and high impedance is not clearly defined, the distinction is still important, primarily because the output impedance of a source determines the length of cable that can be connected between it and a load before a serious loss of high frequencies occurs. The losses occur because all cables have some capacitance between their conductors, especially shielded cables. Some guitar coil cords may measure as high as 1000 picofarads total capacitance! The source impedance, such as a high impedance mixer output, and the capacitance of a cable form a type of low-pass filter, a filter that attenuates high frequencies. This filtering effect can be reduced by using low capacitance cable, by shortening the length of the cable, by using a low impedance source or by some combination of these methods.

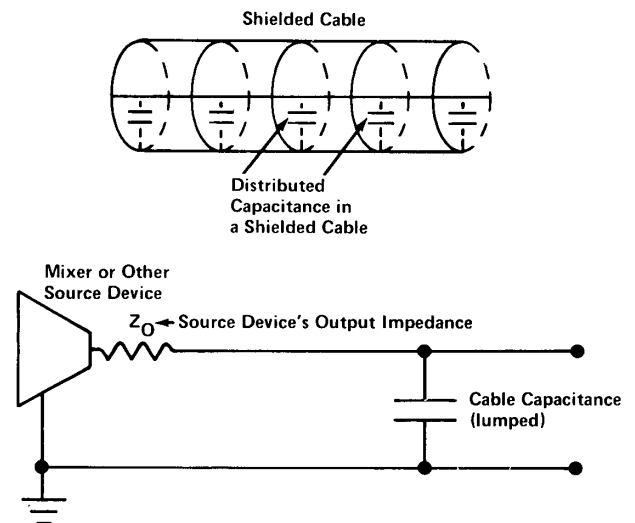

Fig. 32 – The Source's Output Impedance and the Cable Capacitance act as an "RC Lowpass" Filter which Attenuates High Frequencies.

FIVE 2

Cables from high impedance sources (5000 ohms and up), should not be any longer than 25', even if low capacitance cable is used; shorten the cables if the impedance is higher. For low impedance sources of 600 ohms or less, cable lengths to 100' are usable. For very low impedance sources of 50 ohms or less, cable lengths of up to 1000' are possible with minimal loss. However, the frequency response of the source, the desired frequency response of the system, and the amount of capacitance and resistance in the cable all play a role in any potential high frequency losses. Thus, these values are meant as guide lines, and should not be considered fixed rules.

For short runs and in smaller systems with fewer components, the performance of an unbalanced circuit may be adequate. In a long cable run, a balanced or floating circuit tends to reject hum and noise pickup better than an unbalanced circuit, and in complex systems with several components separated by some distance and running on different AC outlets, balanced or floating circuits make proper grounding much easier.

In any given situation, the decision to use a hi-fi device or a professional one should be based on the specifications of the inputs and outputs of that device and on the requirements of the application. Here, reliability and serviceability can be important factors.

OPERATING LEVELS

Nominal professional line level is usually +4dBm or +8dBm; that is, the *average* program level is approximately 1.23V rms (+4dBm), or 1.95V rms (+8dBm) terminated by a 600-ohm line. The peak level may extend to about +24dBm (12.3V rms). The line input (high level input) of professional audio equipment is designed to accept levels on this order of magnitude without overdrive (clipping); most professional equipment can be driven to full output by nominal +4dBm input (source) levels, although a few units require +8dBm (1.95V rms) at their input to yield full output. See the discussion of "Gain Overlap" on Page FIVE 4.

Hi-fi type equipment usually operates at considerably lower line levels than professional equipment, often at -16dB (0.123 volts) to -10dB (0.245 volts) nominal level. Notice we use the expression "dB," not "dBm." This is because "dBm" denotes a *power level* relative to 1mW, or 0.775V rms across a 600-ohm impedance, whereas "dB" denotes a *voltage level* (as defined in this manual) relative to 0.775 rms. This is a subtle distinction, and is explained in greater detail in the Appendix on Page EIGHT 1, and on Page THREE 1 of the specifications.

The nominal -16dB (0.123 volts) level of hi-fi equipment is equal to 123mV rms (123 one-thousandths of a volt) across a 10,000-ohm or higher impedance line. Peak program levels may reach or slightly exceed +4dB (1.23V rms across a high impedance line). Note that a hi-fi unit capable of +4dB (1.23 volts) *maximum* output into a high impedance, does not possess adequate drive for 600-ohm circuits with *nominal* +4dBm level requirements. *Thus, hi-fi equipment is usually incapable of driving professional equipment to its full rated output, at least not without first reaching a high level of distortion.* Moreover, when the output of hi-fi equipment, which is almost always meant to be operated into a high impedance, is connected directly to the low impedance input of professional equipment, the hi-fi unit "sees" a partial short circuit. Depending on the circuitry, this may overload the hi-fi output, or it may simply drop the output level by a few dB. The P2100's input

sensitivity and input impedance are high enough to allow its use with some hi-fi or semi-pro equipment. However, it is a good idea to check the specifications for each situation. The point of this discussion is that impedance and level are extremely important considerations when connecting audio equipment.

DYNAMIC RANGE

Every sound system has an inherent *noise floor* which is the residual electronic noise in the system equipment or the acoustic noise in the room. The effective *dynamic range* of a system is equal to the difference between the peak output level of the system and its noise floor.

120dB SPL is the threshold of pain, and 30dB SPL is the quietest environment one is likely to encounter outside of an anechoic chamber. A concert with sound levels ranging from 30dB SPL to 120dB SPL has a 90dB dynamic range. The electrical signal level in the sound system, given in dB of voltage, is proportional to the original sound pressure level, given in dB SPL, at the microphone. Thus, when the program sound levels reach 120dB SPL, maximum electrical levels at the mixer's output might reach +24dB (12.3 volts), and maximum power levels at the P2100's output might reach 95 watts into an 8-ohm load. Similarly, where sound levels drop to 30dB SPL, minimum electrical levels will drop to -66dB (0.388 milli-volts) and power levels will drop to 95 nano-watts (95 billionths of a watt). These levels are not uncommon. The program still has an electrical dynamic range of 90dB: +24dB - (-66dB) = 90dB. This dB to dB correspondence is maintained throughout the sound system, from the original source at the microphone, through the electrical portion of the sound system, to the speaker system output. A similar correspondence holds for any other type of sound system, a recording studio system, disco system or a broadcast system.

Generally, the average electrical line level in the above sound system is +4dB (1.23 volts) corresponding to an average sound level of 100dB SPL. This average level is usually called the *nominal* program level. The difference between the nominal and the highest (peak) levels in a program is the *headroom*. In the above example, the headroom is 120dB SPL - 100dB SPL = 20dB (not 20dB SPL). Similarly, the electrical headroom is +24dB - (+4dB) = 20dB. This corresponds to a power headroom which is also 20dB.

In the above example, if the system had an electronic noise floor of -56dB (1.23 millivolts), and a peak output level of +18dB (6.16 volts), its dynamic range would only be 74dB. If the original program had a dynamic range of 90dB, then 16dB of the program would be lost in the sound system. There may be extreme clipping of program peaks, some of the low levels may be buried in the noise, or some of the program may be lost in both ways. Thus, it is extremely important to use wide dynamic range equipment, like the P2100 and Yamaha PM-Mixers, in a professional sound reinforcement system.

In the special case of a tape recorder, where the dynamic range is limited by the noise floor and distortion levels of the tape itself, one way to avoid these program losses due to clipping and noise is to "compress" the program's dynamic range (see Page SEVEN 3). A better way is to apply special "noise reduction" equipment which allows the original program dynamics to be maintained throughout the recording and playback process. This improvement in the dynamic range of recorded material again demands wide dynamic range from every piece of equipment in the recording/play-

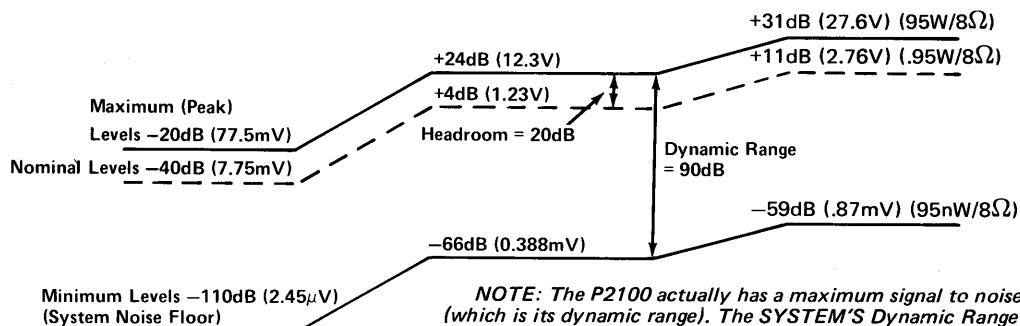
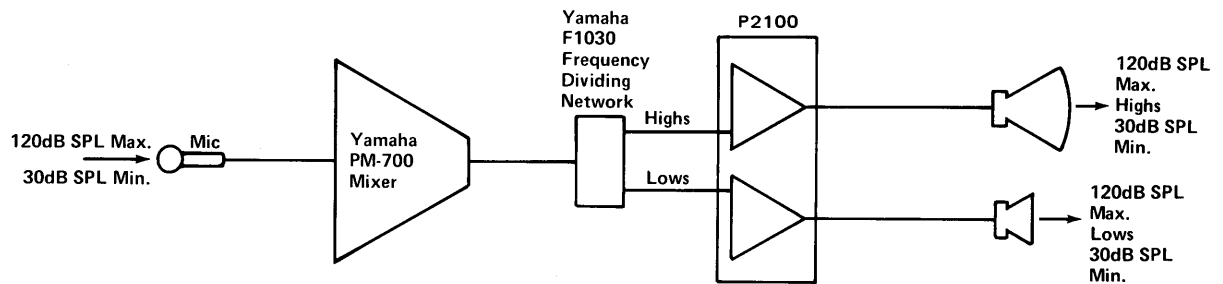
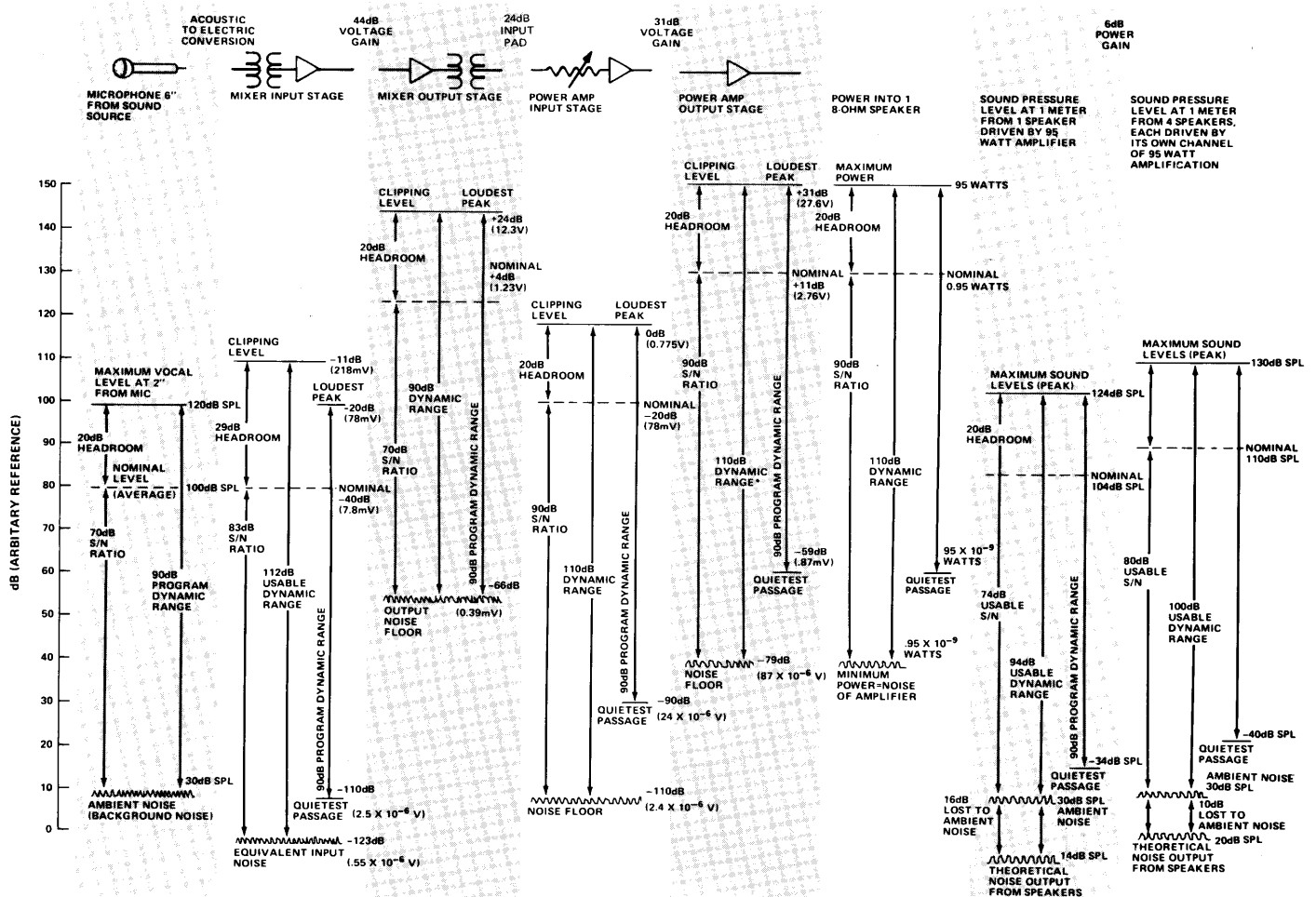

NOTE: The P2100 actually has a maximum signal to noise ratio of 110dB (which is its dynamic range). The SYSTEM'S Dynamic Range is limited by acoustic noise at the mic input, for the system shown, and by the maximum signal to noise ratio of the PM-700 Mixer (93dB), a very respective figure for a high gain device.

Fig. 33 – Dynamic Range in an Audio System

back chain, including the power amplifier.

The P2100 is designed for these wide dynamic range applications. It has exceptionally low noise figures, and high headroom capabilities (high power output). In addition, its operating levels and impedances correspond with professional requirements.

GAIN OVERLAP AND HEADROOM

Yamaha PM-Mixers have +24dB (12.3 volts) maximum output levels. This high output level is advantageous in many situations. One reason is that it assures adequate headroom for driving the input of *any* professional device. High headroom is also important for a mixer that feeds a professional tape recorder, and in a concert sound reinforcement system.

Occasionally a "passive" device (no transistors or tubes) is inserted between the mixer and the power amplifier in a sound reinforcement system, or in a studio monitoring system. Examples of passive devices are passive graphic equalizers, passive low level cross-overs (frequency dividing networks), pads and resistive isolation networks. Passive devices always attenuate the signal level somewhat. For example, a passive low level crossover, when properly terminated, creates a 6dB loss between the mixer and the power amplifier. Passive graphic equalizers can create more than 6dB loss at some frequencies. Because a mixer with +24dB (12.3V) output drive has considerably more output level than is needed to drive the inputs of most amplifiers, passive devices may be used as desired. This extra output capability above that needed to drive the power amplifier is known as "gain overlap," and is one of the most important advantages of a Yamaha PM-Mixer over other mixers, especially non-professional mixers.

INPUT SENSITIVITY RATINGS

Some auxiliary devices have input sensitivities rated like this: "nominal input sensitivity: 0dB". Others may

be rated like this: "input sensitivity: 0dB for rated output". This latter type of rating is typical of many power amplifiers, including the P2100. The difference between these ratings is subtle, but very important. The first device, has a *nominal* input sensitivity of 0dB (0.775 volts), and may be capable of peak levels far above 0dB (0.775 volts); the actual headroom may be stated in another specification. The second device (the P2100 is an example), has a *peak* input sensitivity of 0dB (0.775 volts). A 0dB input signal to the P2100 drives it to full output. Thus, the user must carefully select the system's operating levels.

The gain overlap between maximum mixer output drive capability (typically +24dB) and power amp input sensitivity (0dB) lets the user choose a headroom figure for the P2100; this will be typically 10dB for speech or concert reinforcement, 15 to 20dB for high quality music reproduction or recording. The discussion on Page SIX 5 illustrates the headroom adjustment process.

PROFESSIONAL EQUIPMENT ADVANTAGES

The many advantages of professional equipment include: balanced lines for hum and noise rejection, low impedance circuits for long cable runs, high operating levels for maximum signal to noise ratio, high operating headroom for low distortion and low noise, and reliable XL-type connectors that are unlikely to be disconnected accidentally and that tend not to hum or pop when being attached. In addition, levels and impedances for professional equipment are relatively standardized, which, in many cases, eliminates the need for special adapters, pads, transformers, or preamplifiers. For these reasons, professional equipment, even though its initial cost may be higher, will almost always benefit the user on a long term cost/performance basis.

The P2100 user realizes all of these professional benefits. In addition the P2100 can be used with many hi-fi or semi-pro devices, such as guitar preamps, semi-pro or hi-fi tape machines.

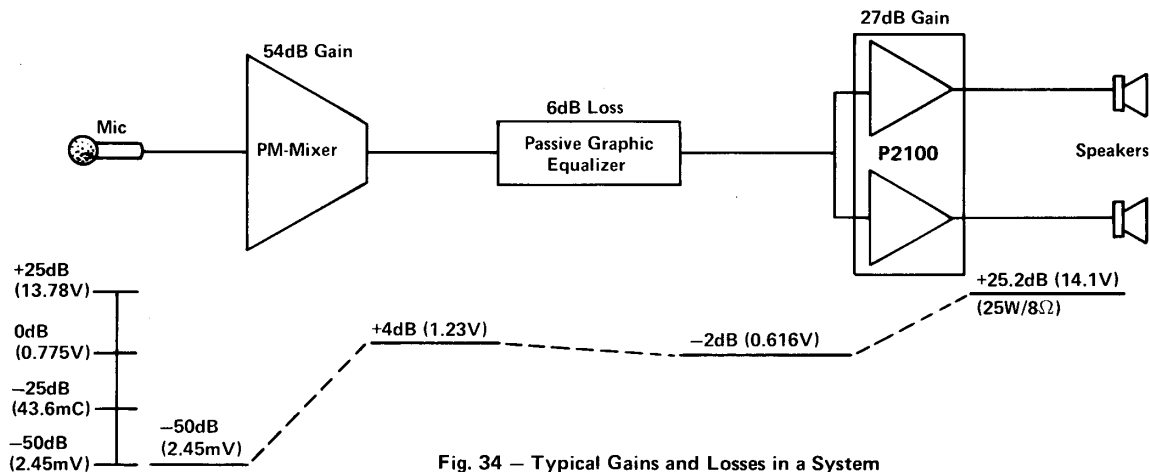

Fig. 34 — Typical Gains and Losses in a System